

Article number: 03552040

Description: Fluro hydraulic rod end FPR 40N

Measures

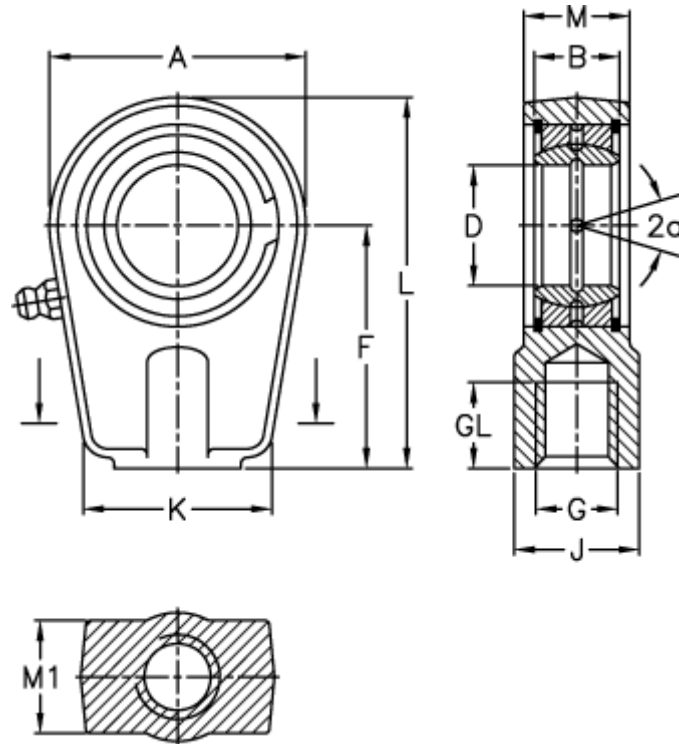

A	= 94	J	= 49
a (degrees)	= 7	K	= 76
B	= 28	L	= 135
D	= 40	M	= 35
Dynamic load C (kN)	= 100	M1	= 33
F	= 85	Static load C0 (kN)	= 250
g	= M35x1,5	Weight	= 2075
GL	= 36		